

M-Series Max Bin Waste Storage System

Product Features



The M-Series Max Bin is a side mounted waste storage solution with large bins that are easily removable. The rigid construction, multiple sizes and heights to choose from, and 45kg (99lb) load capacity make the Max Bin the perfect choice for any kitchen.

- 4 different widths available, unit is adjustable to fit metric and imperial sizes without a conversion kit
- 3 heights available
- Multiple bin configurations
- Full-extension, soft-close, synchronized slides
- Sturdy door mount with full 6-way adjustment
- Modern Anthracite Grey finish
- Roll-out top shelf for additional storage includes removable dark grey anti-slip mat
- Load capacity: 45kg (99lbs)
- Full size positioning template included
- Limited Lifetime Warranty

What's In the Box

1. x1

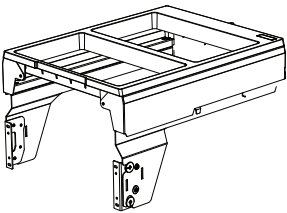

2. x1 pair

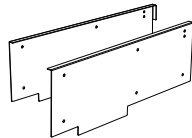

3. x1



4. x1 pair



5. x2

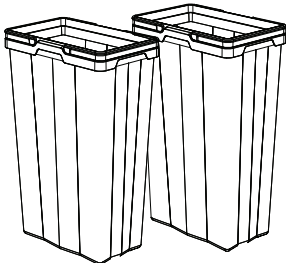

6. x1

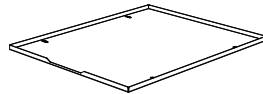

7. x1 pair

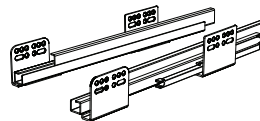

8. x1 pair

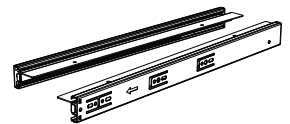

9. x20



10. x4



11. x4



12. x8



13.

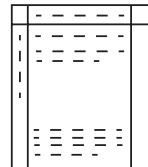

Positioning Template



M-Series Max Bin for 12" (300mm) cabinets

Dimensions (W x H x D)	Capacity	Part#
262 - 280 x 460x 520mm (10 5/16 - 11 x 18 1/8 x 20 1/2")	26L (2 X 13L)	04-MAX300-26S-AG
262 - 280 x 540 x 520mm (10 5/16 - 11 x 21 1/4 x 20 1/2")	30L (2 X 15L)	04-MAX300-30S-AG
262 - 280 x 620 x 520mm (10 5/16 - 11 x 24 13/32 x 20 1/2")	32L (2 X 16L)	04-MAX300-32S-AG

M-Series Max Bin for 16" (400mm) cabinets

Dimensions (W x H x D)	Capacity	Part#
362 - 380 x 460x 520mm (14 1/4 - 14 31/32 x 18 1/8 x 20 1/2")	48L (2 X 24L)	04-MAX400-48S-AG
362 - 380 x 540 x 520mm (14 1/4 - 14 31/32 x 21 1/4 x 20 1/2")	54L (2 X 27L)	04-MAX400-54S-AG
362 - 380 x 620 x 520mm (14 1/4 - 14 31/32 x 24 3/4 x 20 1/2")	62L (2 X 31L)	04-MAX400-62S-AG

M-Series Max Bin for 18" (450mm) cabinets

Dimensions (W x H x D)	Capacity	Part#
412 - 430 x 460x 520mm (16 1/4 - 16 15/16 x 18 1/8 x 20 1/2")	56L (2 X 28L)	04-MAX450-56S-AG
412 - 430 x 540 x 520mm (16 1/4 - 16 15/16 x 21 1/4 x 20 1/2")	66L (2 X 33L)	04-MAX450-66S-AG
412 - 430 x 620 x 520mm (16 1/4 - 16 15/16 x 24 3/4 x 20 1/2")	76L (2 X 38L)	04-MAX450-76S-AG

M-Series Max Bin for 24" (600mm) cabinets

Dimensions (W x H x D)	Capacity	Part#
562 - 580 x 460x 520mm (22 1/8 - 22 27/32 x 18 1/8 x 20 1/2")	74L (2 X 13L + 2 X 24L)	04-MAX600-74S-AG
562 - 580 x 540 x 520mm (22 1/8 - 22 27/32 x 21 1/4 x 20 1/2")	84L (2 X 15L + 2 X 27L)	04-MAX600-84S-AG
562 - 580 x 620 x 520mm (22 1/8 - 22 27/32 x 24 3/4 x 20 1/2")	94L (2 X 16L + 2 X 31L)	04-MAX600-94S-AG

Base Drilling Diagram

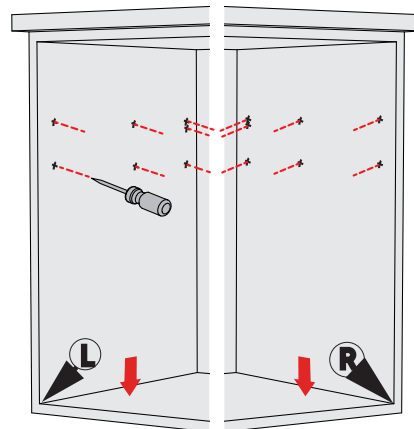
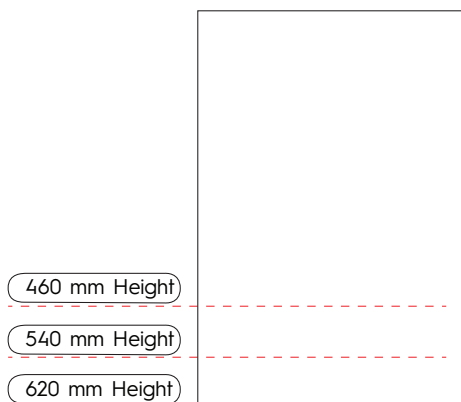

Fold the instruction sheet to the appropriate product height option.

Measure from bottom edge of cabinet and use template to mark holes with awl.

Door Basket Installation

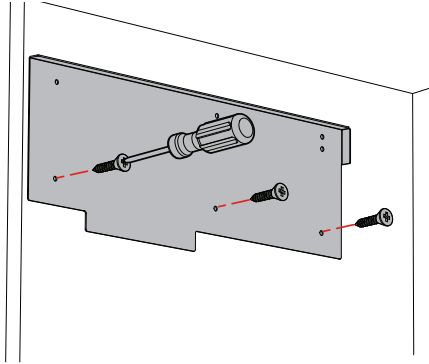

Attach both left and right metal plates to cabinet wall using supplied screws.

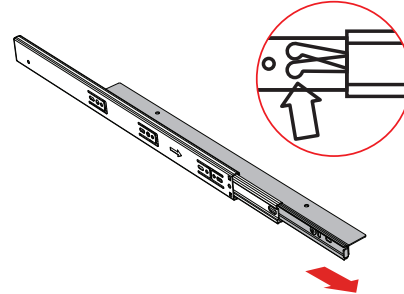

Release left and right tray runners from bracket.

Slide Installation

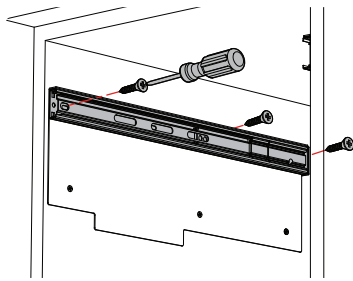

Install the top runners with another 6 bracket screws.

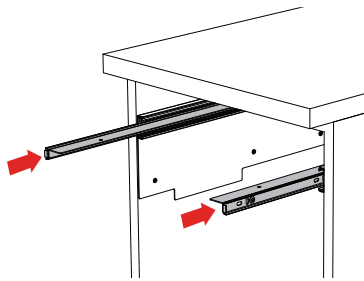

Install top runner brackets. Makes click sound.

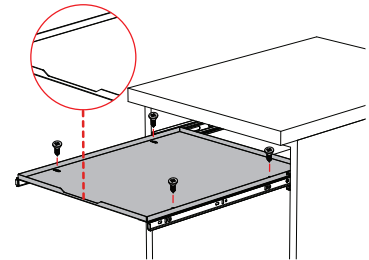

Install metal tray loosely with screws, allowing for adjustment.

Tray & Slide Installation

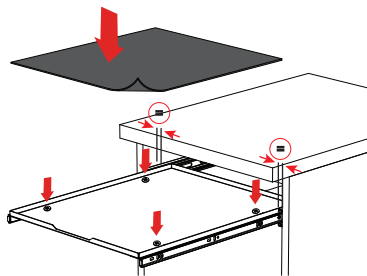

Install metal tray loosely with screws, allowing for adjustment.

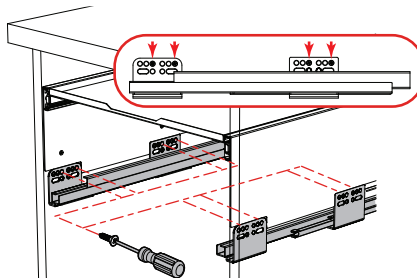

Install metal tray loosely with screws, allowing for adjustment.

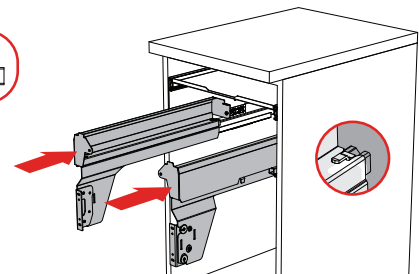

Install metal brackets. Makes click sound.

Bracket Installation Dimension

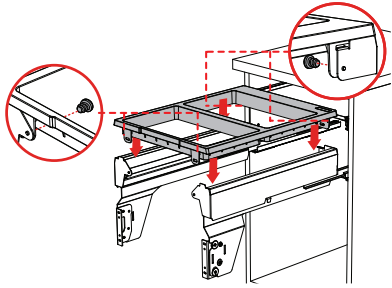

Install plastic tray loosely with screws, allowing for adjustment.

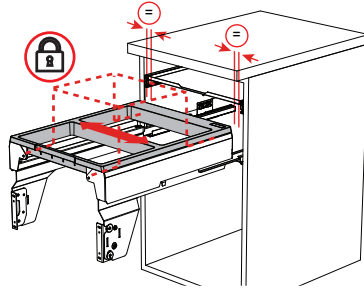

Adjust plastic tray position. Tighten screws when parallel.

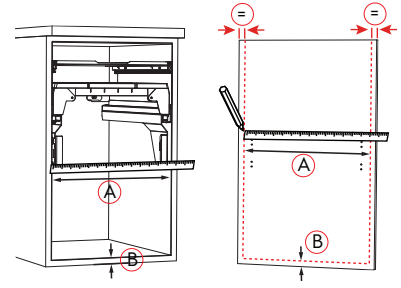

Measure and mark the cabinet bottom and side edge on the door.

Door Bracket Installation

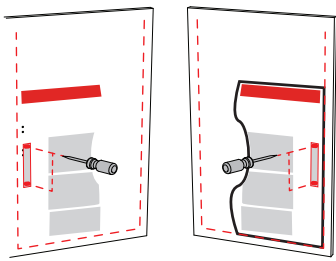

Use template to mark bracket holes on the door.

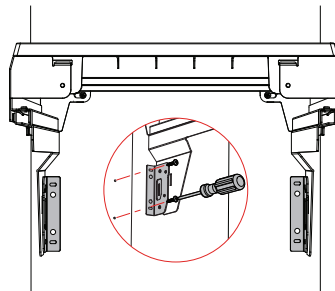

Screw door arms to cabinet using the slotted holes.

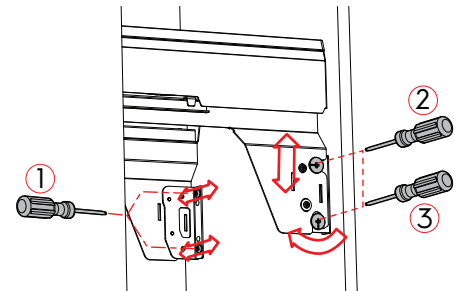

Adjust left and right **1** then tighten. Adjust vertical **2** and tilt **3**.

Fix Bracket Cover

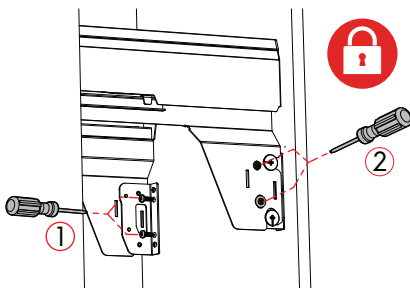

1 Screw the front bracket to the door
2 Lock vertical and tilt adjustment

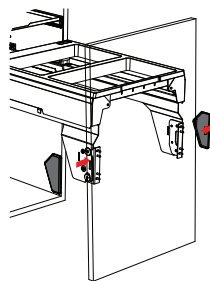

Install screw covers.

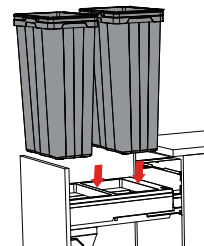

Install Bins.

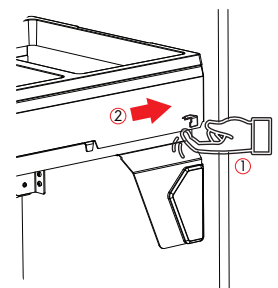

To release brackets from the runners, click switch **1** on the sides of the brackets and slide out **2**.