

Hinge 110 Full Overlay Self-Close Dowels

Part Number: 115-RC575-8D



An economical hinge that is durable and functional, meeting your needs for cabinets and furniture of all kinds.

<div>
</div>

Adjustment Type	2-Way Cam Adjustment
Angle	105 Degree
Application Type	Full Overlay
Closing Type	Self-Close
Cup Type	45mm Standard Pattern
Door Type	Standard Door
Hinge Cup Depth	11.3 mm
Hinge Cup diameter	35 mm
Hinge Door Drilling Distance	3-7 mm
Hinge Door Thickness	14-22 mm
Mounting Type	Dowel (8mm)
Plate Type	Clip-On

Product Advantages

- Quality for Price
- 2-way Cam Adjustment
- Compatible with all M-Series Plates



Technical Documents

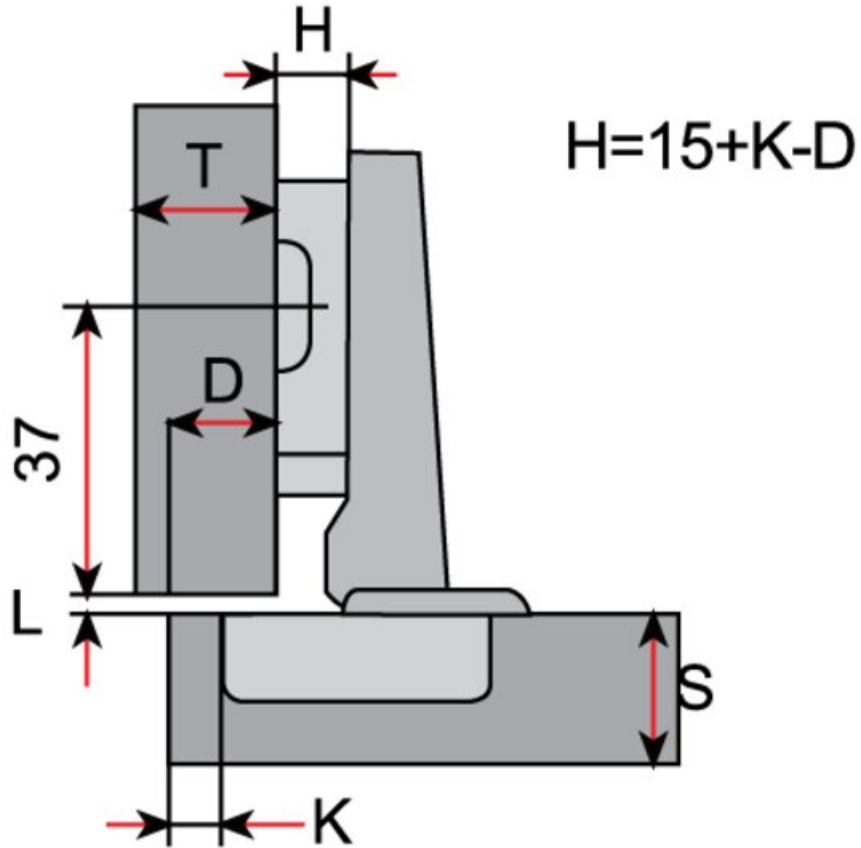

View this product online at <https://marathonhardware.com/pd/115-RC575-8D>



Technical Documents

Full Overlay - Calculation Formula:

$$H = 15 + K - D$$

Hinge Coverage Calculation Table

D \ K	3	4	5	6	7
H					
0	18	19	20	21	22
2	16	17	18	19	20
4	14	15	16	17	18

H = Height of mounting plate

K = Drilling distance from edge of door to edge of cup (TAB)

D = Door overlay on side gable

View this product online at <https://marathonhardware.com/pd/115-RC575-8D>



Technical Documents

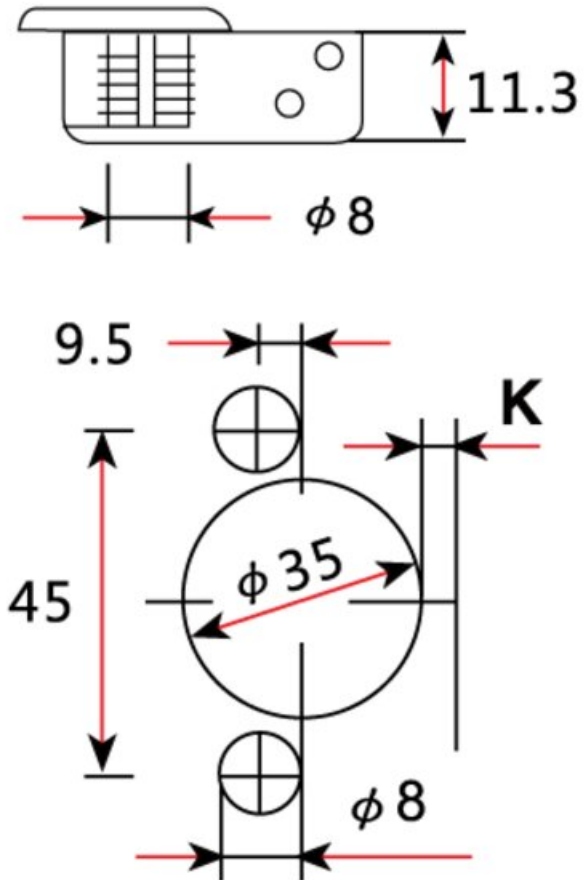

View this product online at <https://marathonhardware.com/pd/115-RC575-8D>



Technical Documents

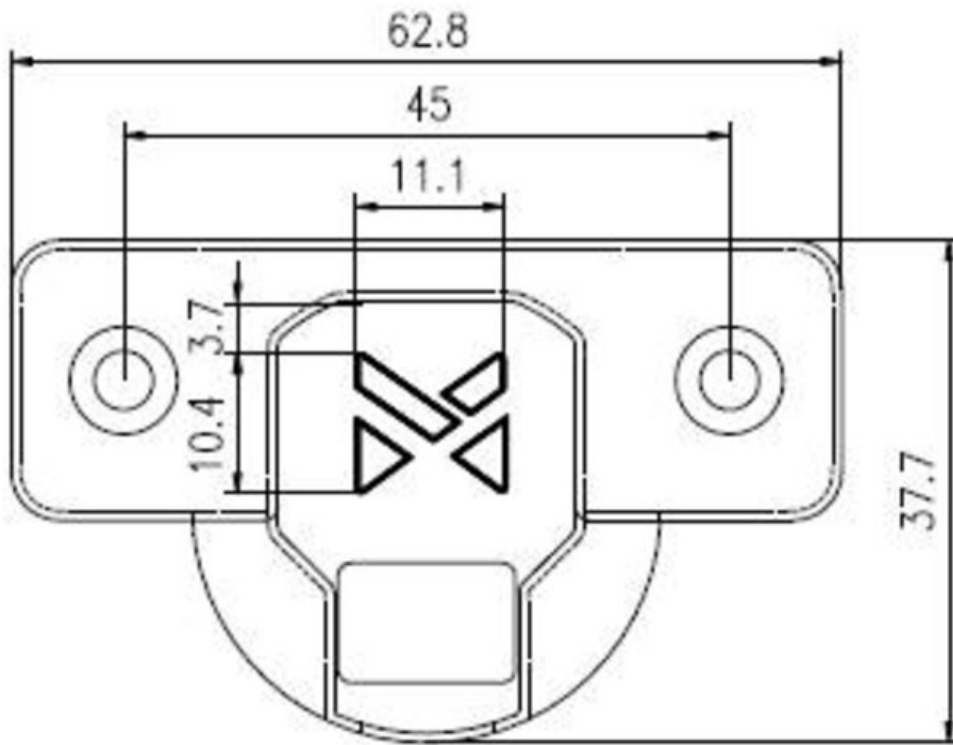

View this product online at <https://marathonhardware.com/pd/115-RC575-8D>



Technical Documents



M-SERIES 110 Degree Hinges

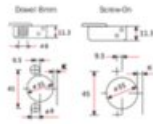

Full Overlay

Part No.	Closing	Fixing	Qty
115-SC575-8D	Soft-Close	Dowel	200
115-RC575-8D	Self-Close	Dowel	200
115-SC575	Soft-Close	Screw-On	200
115-RC575	Self-Close	Screw-On	200

Hinge Coverage Calculation Table

	1	2	3	4	5	6	7
1	10	10	20	27	32		
2	10	17	24	28	30		
3	10	17	24	28	30		

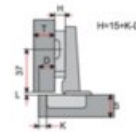

Technical Specifications

- Opening Angle: 110 Degrees
- Diameter of Hinge Cup: 35mm
- Hinge Cup Drilling Depth: 11.3mm
- Hinge Cup Drilling Pattern: 45mm x 9.5mm
- Range of Drilling Distance: 3-7mm
- Range of Door Thickness: 14-22mm

Half Overlay

Part No.	Closing	Fixing	Qty
115-SC585-8D	Soft-Close	Dowel	200

Hinge Coverage Calculation Table

	1	2	3	4	5	6	7
1	5	5	10	13	16		
2	5	7	9	10	10		
3	5	7	9	10	10		

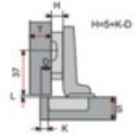

Mounting Plates & Accessories



Part No.	Height	Description	Qty
115-MPO-EUR	0mm	EuroScrew	600
115-MP2-EUR	2mm	EuroScrew	600
115-MPO-CEU	0mm	EuroScrew with Cam Adjust	600
115-MP2-CEU	2mm	EuroScrew with Cam Adjust	600
115-MPO-CAM	0mm	Screw-On with Cam Adjust	600
115-MP2-CAM	2mm	Screw-On with Cam Adjust	600
115-ARC50	-	Limiter 86° Angle Open	1000

Inset

Part No.	Closing	Fixing	Qty
115-SC595-8D	Soft-Close	Dowel	200

Hinge Coverage Calculation Table

	1	2	3	4	5	6	7
1	5	5	10	13	16		
2	5	7	9	10	10		
3	5	7	9	10	10		

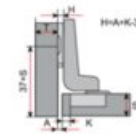

800 840 1228 MARATHONHARDWARE.COM

View this product online at <https://marathonhardware.com/pd/115-RC575-8D>

