

Top Stays Angle Restrictor, 75 Degree



Part Number: 105-SQW75

Restricts the Top Stays opening angle to 75 degree. Snap in, easy to install.

<div>
</div>

Top Hinge Opening Angle ----- 75°

Product Advantages

- Easy to install via clip in
- Allow for crown or cornices above
- Plan gaps for handle clearances



Technical Documents

Top Stays Lift System

How to install Angle Limit Restrictor Clips

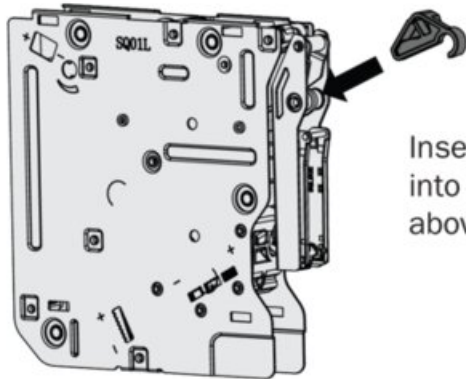

Insert the angle restriction clip into the bottom of the lift arm above the large cylinder.

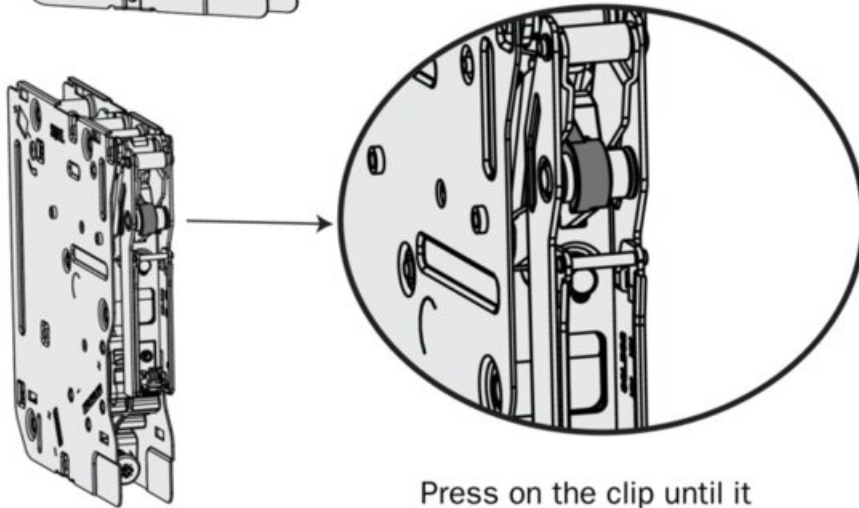

Press on the clip until it snaps in place securely.

