



## Filler Pullout 5 Shelf Soft-Close Left

**Part Number: 041-VFPO-15L**

Vibo Narrow Filler Pullout - Left

The Vibo Galaxy Tall Filler Pullout is a fixed 5-shelf storage solution for narrow cabinets. Now available in the euro-wire. Suits narrow 150mm or 6" cabinets with more than 1700mm (67") internal height clearance.

<div><br></div>

Basket Bottom Type	Wire Bottom
Basket Wire Finish	Chrome
Baskets Included?	Yes
Closing Type	Soft-close
Finish	Chrome
Frame Finish	Light Grey
Frame Type	Tall
Interior Depth Required	470 mm (18-3/8 in)
Interior Height Required	1700 mm (67 in)
Interior Width Required	107 mm (4-1/8 in)
Mounting Side	Left
Opening Direction	Right (Accessible)
Order	Left-mount (Right accessible)
Pullout Type	Pantry
Reversible	Non-reversible
Slide Extension Type	Full Extension
Suggested for Cabinet (Door) Width	150 mm (6 in)

### Product Description

The Vibo Galaxy Tall Filler Pullout is a fixed 5-shelf storage solution for narrow cabinets. Now available in the euro-wire. Suits narrow 150mm or 6" cabinets with more than 1700mm (67") internal height clearance.

### Product Advantages





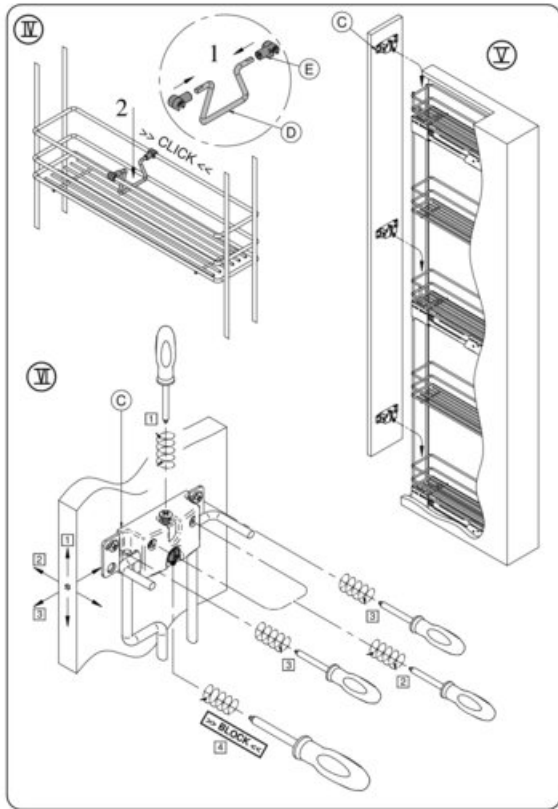





- Runs on three left side-mounted full-extension, soft-close slides
- Concealed slides do not block storage access from either side
- Includes 3 door-mount brackets with 6-way adjustment, Includes 4 snap-on bottle dividers
- Fixed height, non adjustable.
- Load capacity: 60kg (132lbs)
- Euro-Wire

## Technical Documents

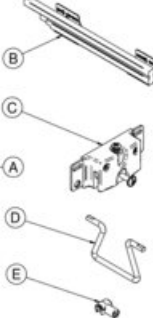

20/01/2014 cod. 4004116530

4/4

	Portata massima: Maximum load: Charge max: Maximaler beladbarkeit: Cargo maxime:	60 Kg	<b>Istruzioni di montaggio</b> Assembling instructions Notice de montage Montageanleitung Manual de montaje			
			<b>ELQGM155DXPRPC</b> <b>ELQGM155SXPRPC</b>			
		10 min			1	
				<b>PRIMA DI COMINCIARE, VEDERE I CONSIGLI DI MONTAGGIO</b> BEFORE STARTING, REFER TO THE ASSEMBLING ADVICE IN ANNEX. AVANT DE COMMENCER, SE REPORTER AUX CONSEILS DE MONTAGE EN ANNEXE. VOR DIE MONTAGE, BITTE BEZIEHENDEN FOLDEN. ANTES DE EMPEZAR CONSULTA LOS CONSEJOS PARA EL MONTAJE.		
						
A x 1	B x 3	C x 3	D x 4	E x 8		

20/01/2014 cod. 4004116530

1/4

View this product online at <https://marathonhardware.com/pd/041-VFPO-15L>

## Technical Documents

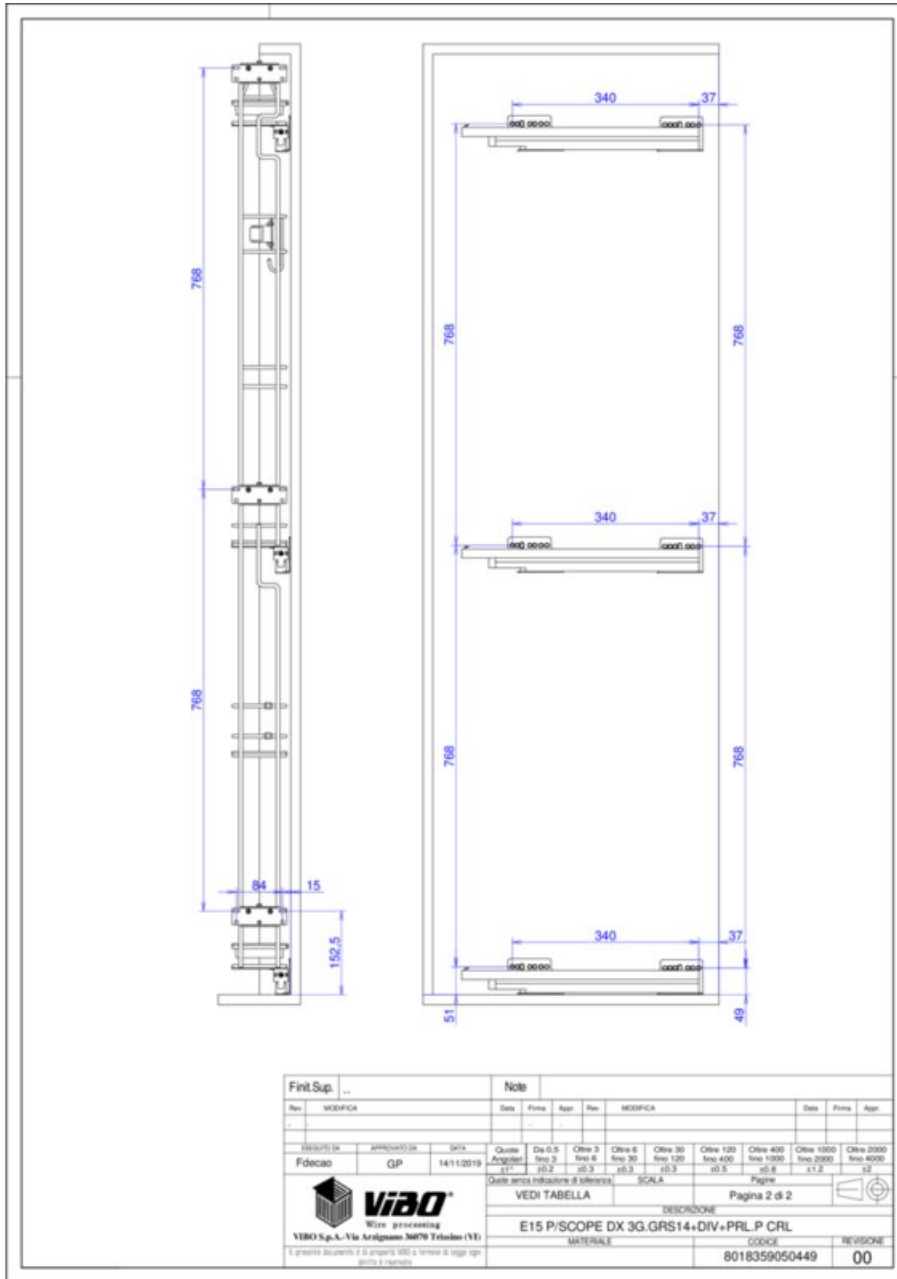

View this product online at <https://marathonhardware.com/pd/041-VFPO-15L>

