



## Kidney Lazy Susan 32 in Dia. Anthracite Dark Grey

**Part Number: 041-VGLQ834-AG**

Vibo Galaxy Kidney Shape Lazy Susan, 32 in, Anthracite Grey

Kit consists of 2 baskets featuring single elliptical rail with anti-slip melamine bottom. Fast block fittings included but Adjustable Post sold separately.

Basket Bottom Colour	Dark Grey
Basket Bottom Type	Anti-Slip Melamine
Basket Wire Finish	Anthracite
Diameter	815 mm (32-1/16 in)
Finish	Anthracite Grey
Frame Finish	Chrome

### Product Description

From Vibo's Galaxy Collection comes the kidney (three-quarter) shaped Lazy Susan which is subtly attractive, durable, and easy to clean. Available in both in the new Anthracite Grey finish and the White/Chrome and Maple/Champagne finishes. Height adjustable shelves are easy to install with "fast block fittings".

### Product Advantages

- Available for 2 diameters: 28 or 32 inches
- Premium elliptical wire and anti-slip coated melamine bottoms
- Load capacity on 28" per shelf: 13kg (29lbs)
- Load capacity on 32" per shelf: 16kg (35lbs)



## Technical Documents

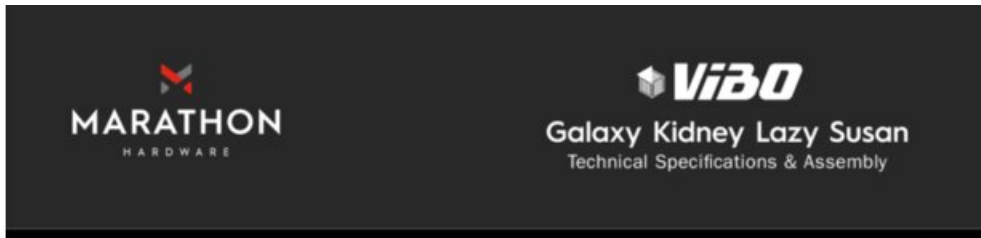

### Galaxy Kidney Lazy Susan



### Product Features

From Vibo's Galaxy Collection comes the kidney (three-quarter) shaped Lazy Susan which is subtly attractive, durable, and easy to clean. Available in Anthracite Dark Grey finish and the White/Chrome and Maple/Champagne finishes. Height adjustable shelves are easy to install with "fast block fittings".

- Ideal for 45 degree corner cabinets
- Available in 450, 715 and 815mm (18", 28" and 32")
- Anti-slip melamine bottom which is TSCA Title VI compliant
- Load Capacity: 17kg (37lbs) per shelf for 18" & 28" size 21kg (46lbs) per shelf for 32" size

### Adjustable Height Metal Post, Chrome

Description	Part#
645 - 720mm (25 1/4" - 28 1/4")	041-VSGTB5002C

### Baskets set of 2 including Fast-Block fittings

Description	Finish	Part#
⊙ x H 715 x 645 - 720mm (28 1/4" x 25 1/4" - 28 1/4")	Anthracite Dark Grey	041-VGLQ734-AG
⊙ x H 715 x 645 - 720mm (28 1/4" x 25 1/4" - 28 1/4")	White & Chrome	041-VGLQ734-WHC
⊙ x H 715 x 645 - 720mm (28 1/4" x 25 1/4" - 28 1/4")	Champagne/Maple	041-VGLQ734-VCH
⊙ x H 715 x 645 - 720mm (28 1/4" x 25 1/4" - 28 1/4")	Chrome	041-VGLQ734-C
⊙ x H 815 x 645 - 720mm (32 1/4" x 25 1/4" - 28 1/4")	Anthracite Dark Grey	041-VGLQ834-AG
⊙ x H 815 x 645 - 720mm (32 1/4" x 25 1/4" - 28 1/4")	White & Chrome	041-VGLQ834-WHC
⊙ x H 815 x 645 - 720mm (32 1/4" x 25 1/4" - 28 1/4")	Champagne/Maple	041-VGLQ834-VCH
⊙ x H 815 x 645 - 720mm (32 1/4" x 25 1/4" - 28 1/4")	Chrome	041-VGLQ834-C

### Minimum Interior Cabinet Dimensions

- ⊙ x H 715 x 645 - 720mm (28 1/4" x 25 1/4" - 28 1/4")
- ⊙ x H 815 x 645 - 720mm (32 1/4" x 25 1/4" - 28 1/4")

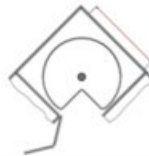

800.840.1228 / MARATHONHARDWARE.COM

View this product online at <https://marathonhardware.com/pd/041-VGLQ834-AG>



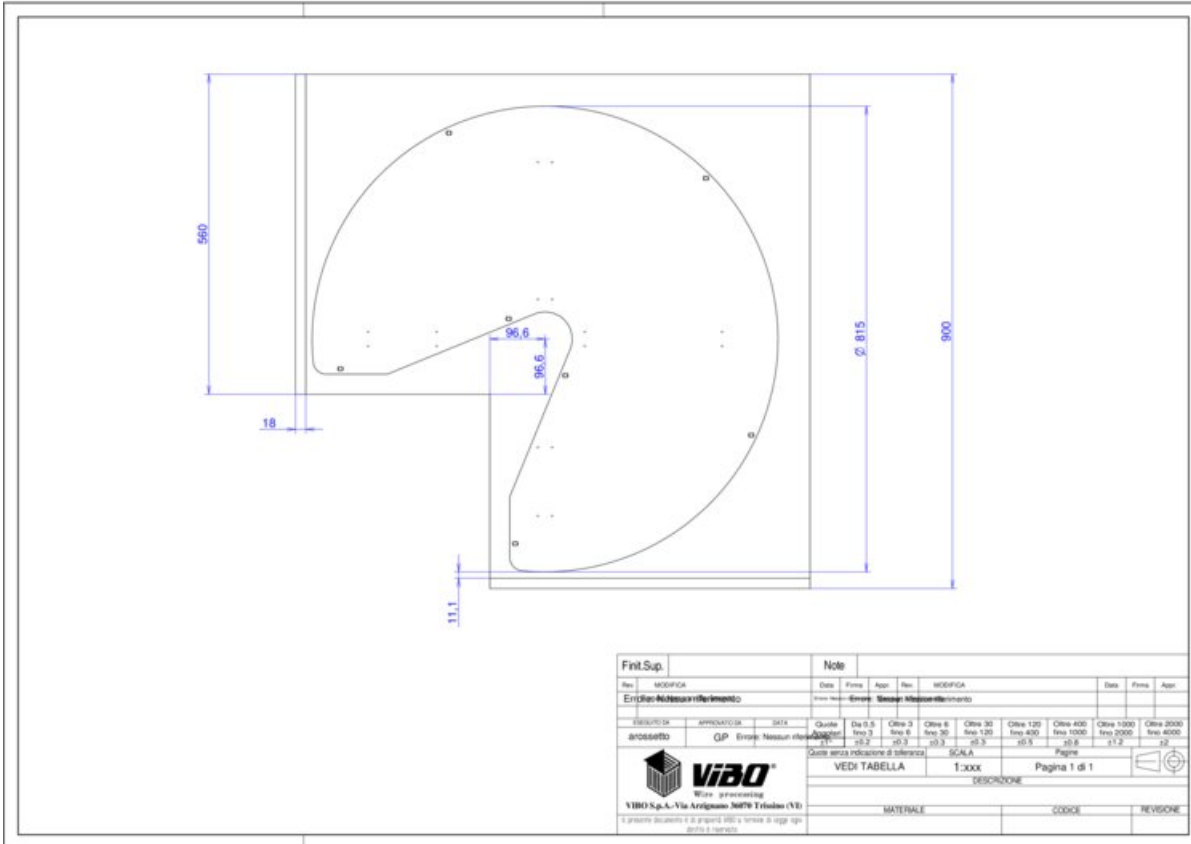





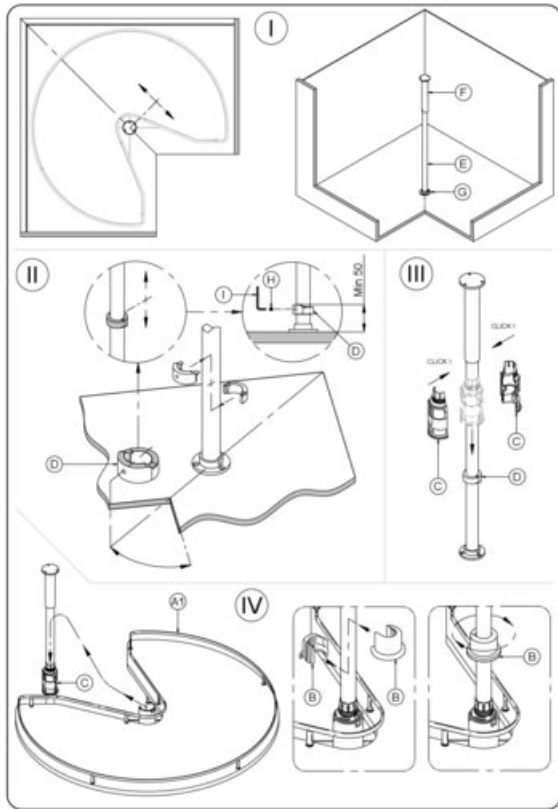





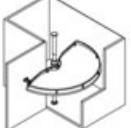
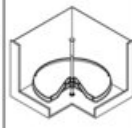

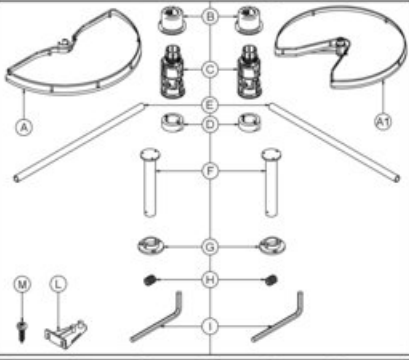

## Technical Documents



View this product online at <https://marathonhardware.com/pd/041-VGLQ834-AG>

## Technical Documents



	Portata massima per centro Maximum load per handle Charge max pour passer Maximala belastbarkeit pro Loch Carga maxima per centro	 660 9 Kg  760 11 Kg  734 13 Kg  834 16 Kg	<b>Istruzioni di montaggio</b> Assembling instructions Notice de montage Montageanleitung Manual de montaje
	 	<b>KCM660..TFBOM</b> <b>KCM760..TFBOM</b> <b>CG734..FBM2OM</b> <b>CG834..FBM2OM</b>	
	 20 min  1		
			<b>PRIMA DI COMINCIARE, VEDERE I CONSIGLI DI MONTAGGIO</b> BEFORE STARTING, REFER TO THE ASSEMBLING ADVICE IN ANNEX. AVANT DE COMMENCER SE REPORTER AUX CONSEILS DE MONTAGE EN ANNEXE. VOR DIE MONTAGE, BITTE BEIHEGENDE ANWEISUNGEN FOLGEN. ANTES DE EMPEZAR CONSULTAR LOS CONSEJOS PARA EL MONTAJE.
 A x 2  A1 x 2  B x 2  C x 2  D x 2  E x 1  F x 1  G x 1  H x 5  I x 2  L x 1  M x 2			
17/12/2012 cod. 4004115200			1/4

View this product online at <https://marathonhardware.com/pd/041-VGLQ834-AG>

