



## Legacy Prima Glass Drawer System 500mm Silk White

**Part Number: 105-HG88-SW500**

DTC Legacy Prima Drawer System 500mm Length, 88mm Height, Silk White

Legacy Prima is a slim box drawer system featuring premium materials, technology and design. Synchronized soft-close slide with 40kg load capacity.

Closing Type	Soft-Close
Colour	Silk White
Drawer Side Height	88 mm
Drawer System	Legacy Prima
Drawer Type	Standard Drawer
Length	500mm (20in)
Load Capacity	40kg (88lbs)
Material	Premium Metal
Slide Extension Type	Full Extension
Slide Type	Synchronized

### Product Description

Legacy Prima is the new name for our existing high-quality drawer system. Available with dozens of options to fully customize your project and fit it to the exact specifications and needs of your client. Seven lengths and four available heights, including sleek and stylish glass options on two of the heights, give you the option to create a high end space designed for your client's lifestyle.

### Product Advantages

- Maximize internal storage and usable space
- Convey contemporary style and design
- Synchronized soft-close slides for ultra smooth and silent motion
- High dynamic load capacity of 40 kg (88 lbs)
- Range of colours that match and compliment today's modern looks
- 3 heights, 7 lengths and a complete range of accessories in glass and metal
- Tool-free assembly and installation
- No extra machining required on bottom panel

### Important Information

Legacy Glass Drawer Kits do NOT include the decorative glass side inserts. **Glass Sides MUST be ordered separately as indicated in the required products.** Our catalogue previously indicated these would be included which was changed to better protect the glass during packaging and shipping.



## Technical Documents

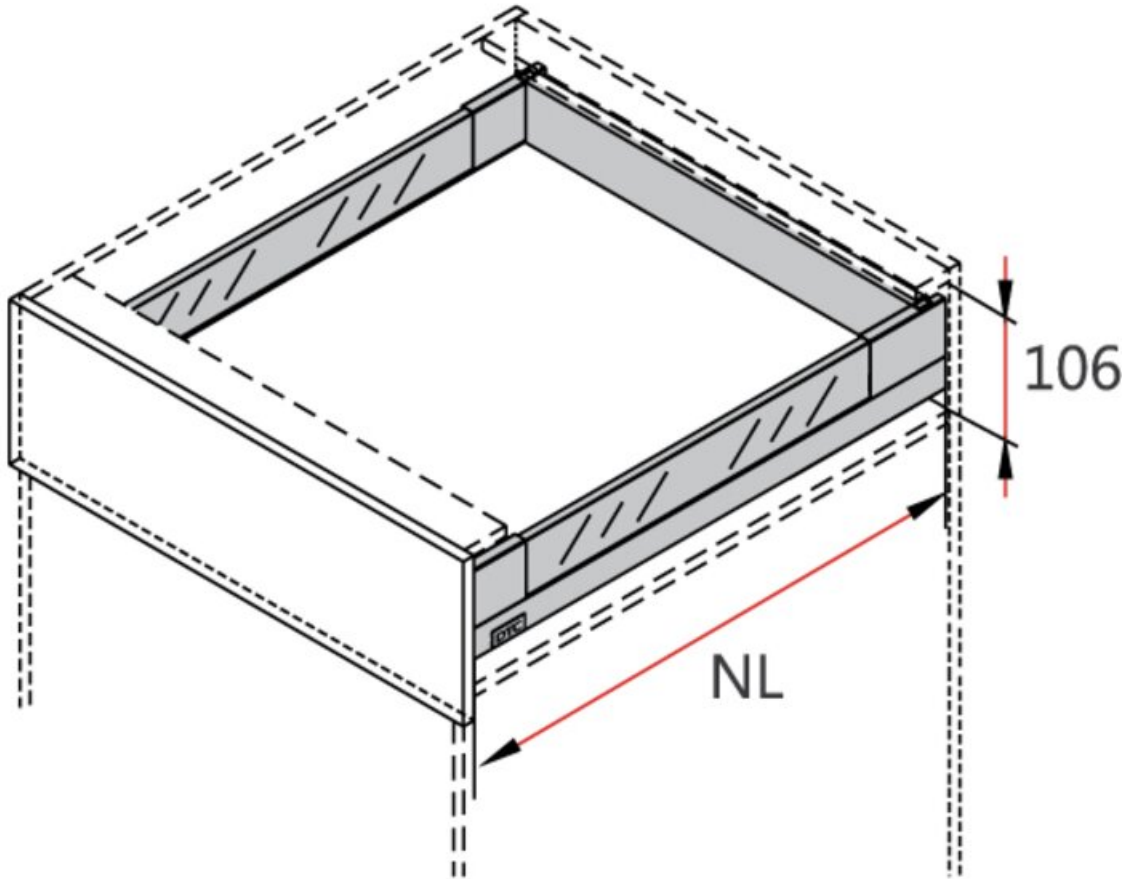

NL:Nominal length

View this product online at <https://marathonhardware.com/pd/105-HG88-SW500>



## 10mm Glass-boxside

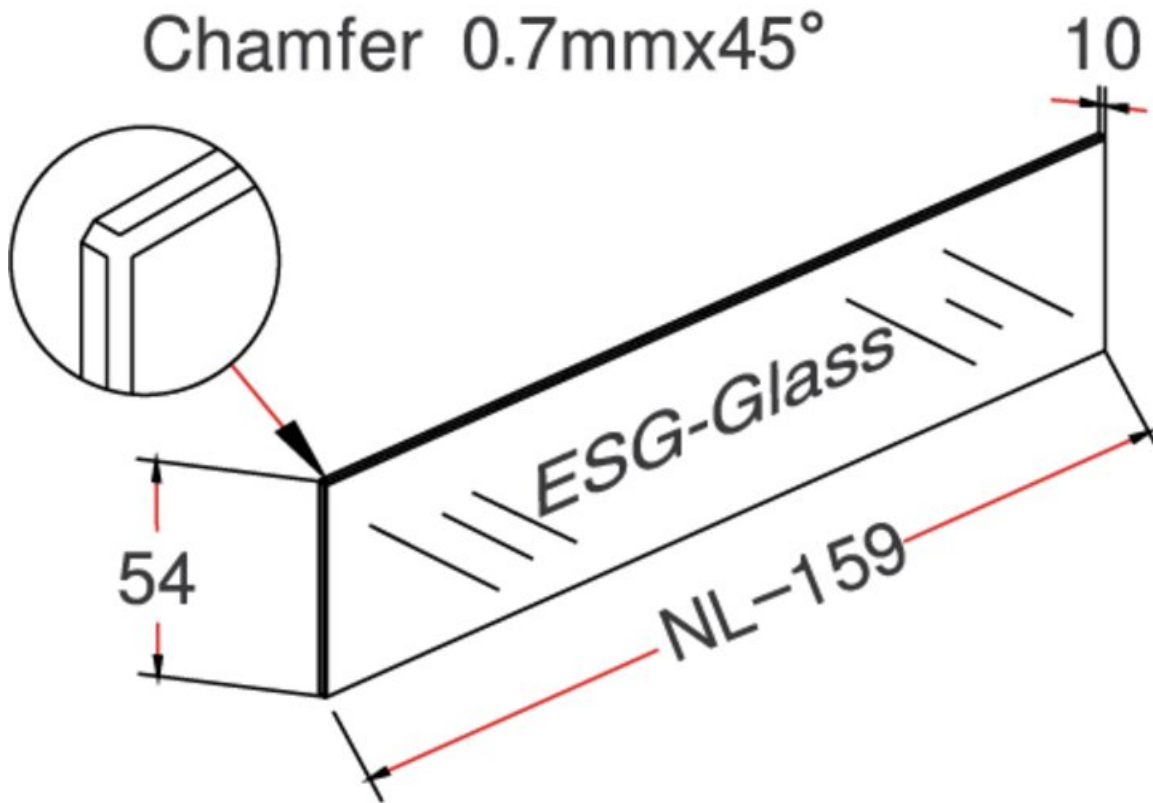

View this product online at <https://marathonhardware.com/pd/105-HG88-SW500>



## Technical Documents

### Drawer Front

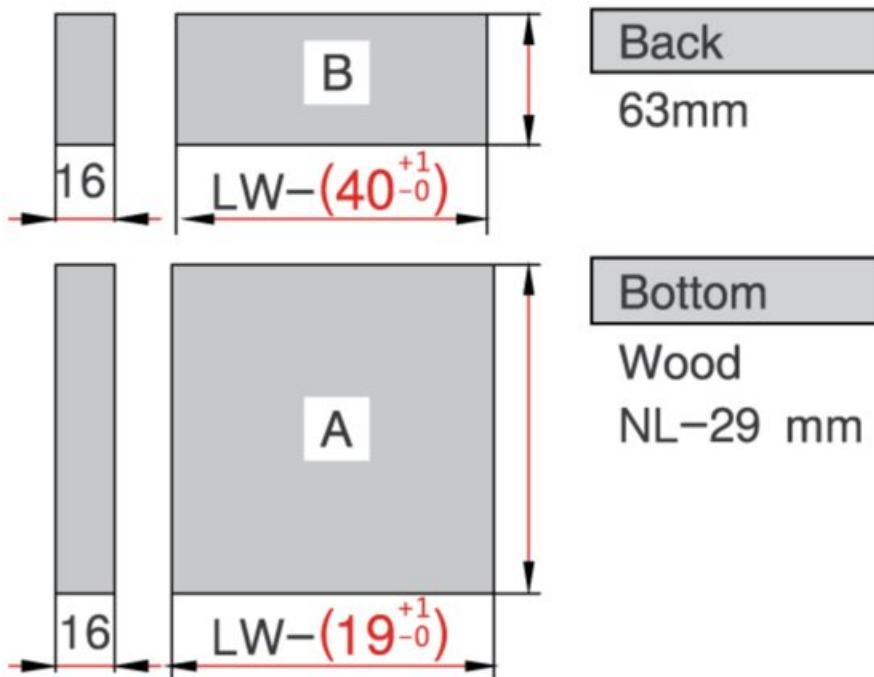
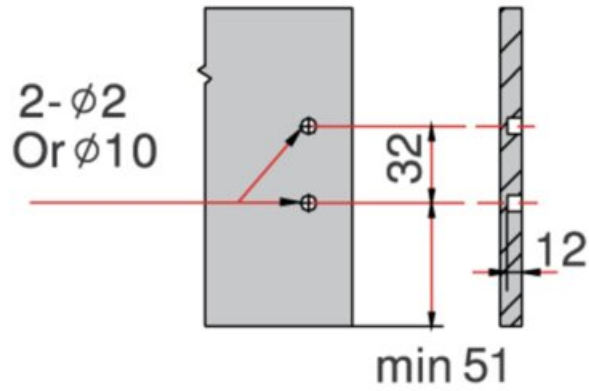

View this product online at <https://marathonhardware.com/pd/105-HG88-SW500>

Technical Documents

LW=Internal Cabinet Width

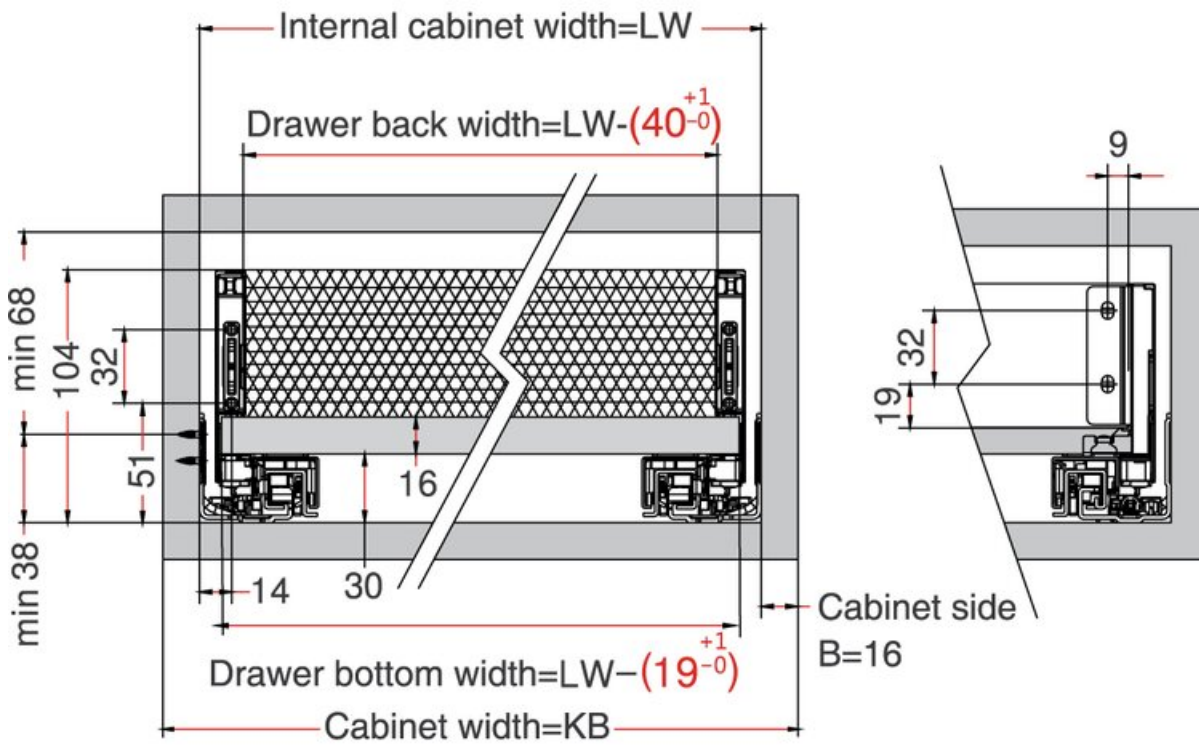

View this product online at <https://marathonhardware.com/pd/105-HG88-SW500>



## Technical Documents

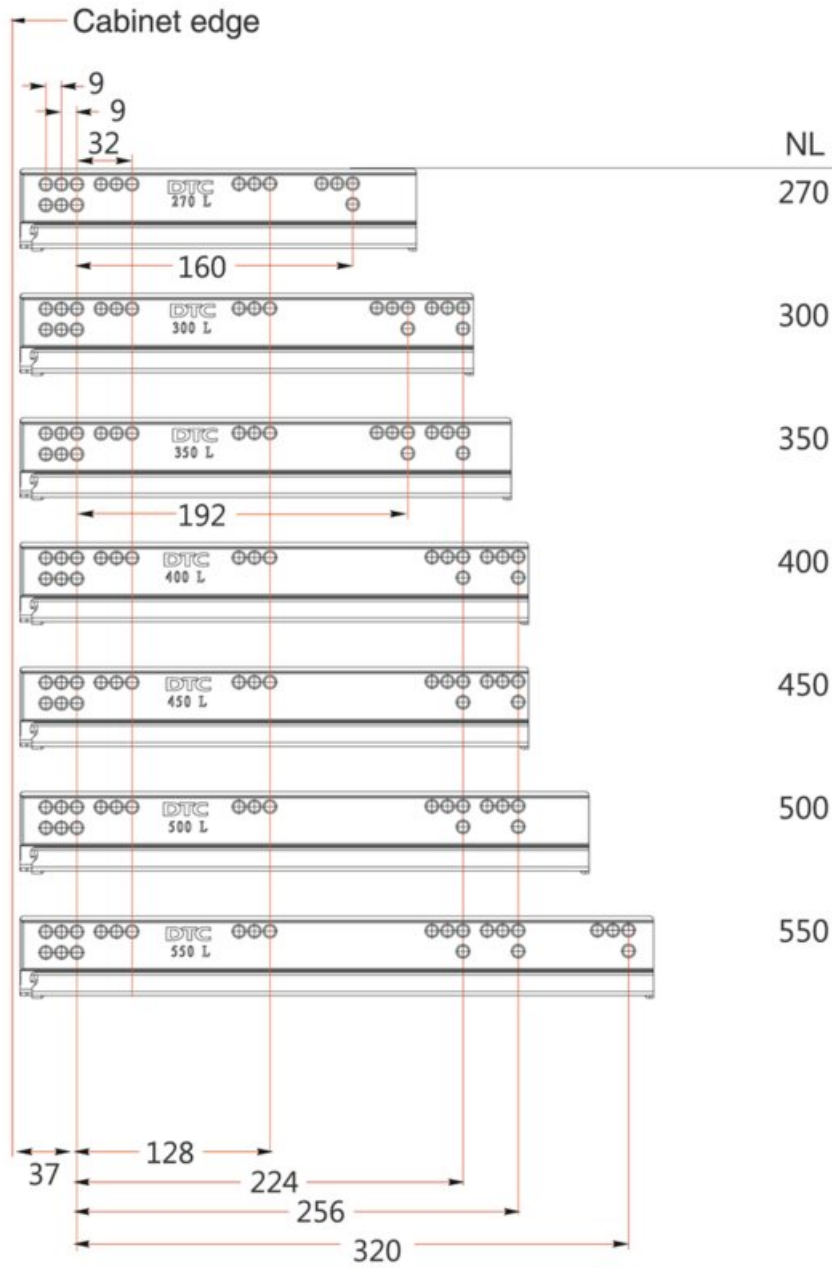

View this product online at <https://marathonhardware.com/pd/105-HG88-SW500>

Technical Documents

NL=Nominal Slide Length  
LT=Internal Cabinet Depth  
LT=NL+3

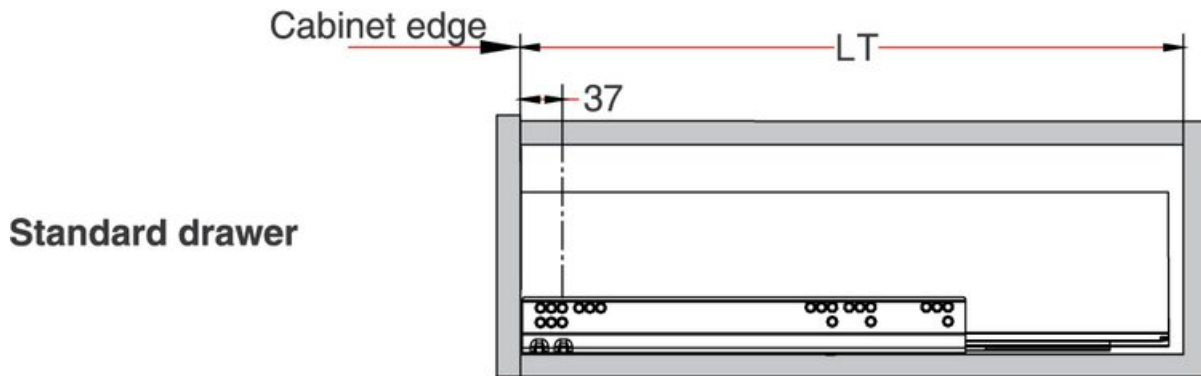

View this product online at <https://marathonhardware.com/pd/105-HG88-SW500>



## Technical Documents

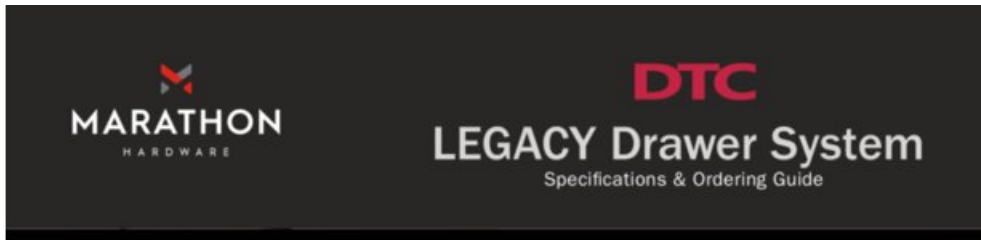

### Standard Glass Drawer Kit, 88mm M Height

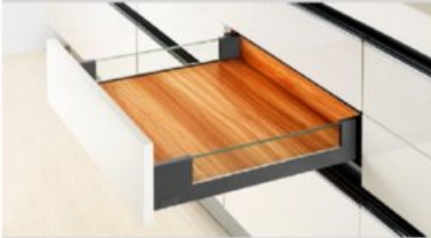

### Product Features

- Modern Straight Slim box drawer system
- Silent system guarantees quiet, smooth run
- High dynamic load capacity: 40/60kg (88/132lbs)
- Concealed slide with full extension
- Tool free assembly and removal of drawer
- 3D Adjustment

### Glass Sides Drawer Kit (packaged as a complete set)

#### Glass Sides Drawer Kit with 88mm M Height sides include:

- One pair of Full Extension Soft-Close Slides
- One pair of Legacy Drawer Sides (88mm M Height) and connectors for use with Glass Sides
- Pre-cut Glass Sides for use with M Height
- One set of inner/outer Cover Caps
- One pair of rear fixing brackets
- Two universal drawer front connectors

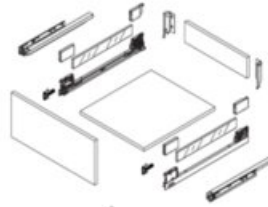

### Standard Drawer Kit (Matte Grey) Ordering Guide

Length (mm)	Length (Inch)	Matte Grey	Silk White
270mm	11"	105-HG88-GM270	105-HG88-SW270
300mm	12"	105-HG88-GM300	105-HG88-SW300
350mm	14"	105-HG88-GM350	105-HG88-SW350
400mm	16"	105-HG88-GM400	105-HG88-SW400
450mm	18"	105-HG88-GM450	105-HG88-SW450
500mm	20"	105-HG88-GM500	105-HG88-SW500
550mm	22"	105-HG88-GM550	105-HG88-SW550

800 840 1228 · MARATHONHARDWARE.COM

View this product online at <https://marathonhardware.com/pd/105-HG88-SW500>



