

Pull TRIBECA 5" PC

Part Number: E86489US26



EMTEK Tribeca Pull, 5", Polished Chrome

The diamond pattern Tribeca pull adds a unique design flare to kitchens ranging from classic to contemporary.

Center to Center Length	5 in
Collection	Tribeca
Finish Code	Polished Chrome
Material	Zinc Diecast
Overall Length	7 in
Projection (Height)	1.25 in
Style Family	Art Deco
Type	Pull

Product Description

Capturing the trendy essence of Tribeca in lower Manhattan, the Emtex Tribeca Cabinet Pull exudes a hip vibe inspired by the area's industrial roots. Its diamond-shaped and geometrically textured style reflects the unique energy of the neighborhood. This versatile piece is designed for use on paneled kitchen appliances or as a standalone door pull, offering a multi-faceted texture with distinctive light reflection properties.

Available in 7 sizes and 6 finishes, the Tribeca Cabinet Pull allows you to customize your space with a modern touch. Whether you're looking to elevate your cabinets or add a chic design element, this pull embodies the cool spirit of its New York namesake. Explore the possibilities and bring a touch of Tribeca's trendiness to your surroundings.

Product Advantages

- 7 lengths (centre-to-centre): 3-1/2", 4", 5", 6", 8", 10", 12"
- 6 finishes
 - Oil-rubbed bronze
 - Polished Nickel
 - Satin Nickel
 - Flat Black
 - Polished Chrome
 - Stain Brass

Included Products

Industry Standard Fastening Hardware



Technical Documents

ART DECO

Cabinet Knobs & Pulls Technical Specifications

EMTEK

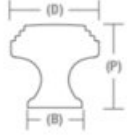

Art Deco Knob

		Product Code	Dimension(D)	Projection(P)	Base Dimension(B)
		86421	1 1/4"	1 1/4"	3/4"

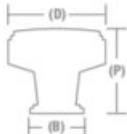

Newport Knob

		Product Code	Dimension(D)	Projection(P)	Base Dimension(B)
		86432	1 1/4"	1 1/4"	3/4"
		86433	1 3/8"	1 1/2"	1"

Art Deco Pull

		Product Code	Dimension C-to-C	Overall	Projection(P)	Base Dimension(B)
		86422	3 1/2"	4 3/8"	1 1/8"	1/2"
		86423	4"	4 7/8"	1 1/8"	1/2"

Alexander Pull

		Product Code	Dimension C-to-C	Overall	Projection(P)	Base Dimension(B)
		86424	3 1/2"	4 3/8"	1 1/8"	1/2"
		86425	4"	4 3/8"	1 1/8"	1/2"
		86484	5"	5 3/8"	1 1/8"	1/2"
		86426	6"	6 3/8"	1 1/8"	1/2"
		86427	8"	8 3/8"	1 1/8"	1/2"
		86485	10"	10 3/8"	1 1/8"	1/2"
		86479	12"	12 3/8"	1 1/8"	1/2"

Emtek Products, Inc. Tel: 800.356.2741 Fax: 800.577.5771 emtek.com

View this product online at <https://marathonhardware.com/pd/E86489US26>

