

Pull TRIBECA 12" PC

Part Number: E86491US26



EMTEK Tribeca Pull, 12", Polished Chrome

The diamond pattern Tribeca pull adds a unique design flare to kitchens ranging from classic to contemporary.

Center to Center Length	12 in
Collection	Tribeca
Finish Code	Polished Chrome
Material	Zinc Diecast
Overall Length	14 in
Projection (Height)	1.375 in
Style Family	Art Deco
Type	Pull

Product Description

Capturing the trendy essence of Tribeca in lower Manhattan, the Emtex Tribeca Cabinet Pull exudes a hip vibe inspired by the area's industrial roots. Its diamond-shaped and geometrically textured style reflects the unique energy of the neighborhood. This versatile piece is designed for use on paneled kitchen appliances or as a standalone door pull, offering a multi-faceted texture with distinctive light reflection properties.

Available in 7 sizes and 6 finishes, the Tribeca Cabinet Pull allows you to customize your space with a modern touch. Whether you're looking to elevate your cabinets or add a chic design element, this pull embodies the cool spirit of its New York namesake. Explore the possibilities and bring a touch of Tribeca's trendiness to your surroundings.

Product Advantages

- 7 lengths (centre-to-centre): 3-1/2", 4", 5", 6", 8", 10", 12"
- 6 finishes
 - Oil-rubbed bronze
 - Polished Nickel
 - Satin Nickel
 - Flat Black
 - Polished Chrome
 - Stain Brass

Included Products

Industry Standard Fastening Hardware



Technical Documents

ART DECO

Cabinet Knobs & Pulls Technical Specifications

EMTEK

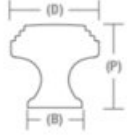

Art Deco Knob

		Product Code	Dimension(D)	Projection(P)	Base Dimension(B)
		86421	1 1/4"	1 1/4"	3/4"

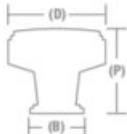

Newport Knob

		Product Code	Dimension(D)	Projection(P)	Base Dimension(B)
		86432	1 1/4"	1 1/4"	3/4"
		86433	1 3/8"	1 1/2"	1"

Art Deco Pull

		Product Code	Dimension C-to-C	Overall	Projection(P)	Base Dimension(B)
		86422	3 1/2"	4 3/8"	1 1/8"	1/2"
		86423	4"	4 3/8"	1 1/8"	1/2"

Alexander Pull

		Product Code	Dimension C-to-C	Overall	Projection(P)	Base Dimension(B)
		86424	3 1/2"	4 3/8"	1 1/8"	1/2"
		86425	4"	4 3/8"	1 1/8"	1/2"
		86484	5"	5 3/8"	1 1/8"	1/2"
		86426	6"	6 3/8"	1 1/8"	1/2"
		86427	8"	8 3/8"	1 1/8"	1/2"
		86485	10"	10 3/8"	1 1/8"	1/2"
		86479	12"	12 3/8"	1 1/8"	1/2"

Emtek Products, Inc. Tel: 800.356.2741 Fax: 800.577.5771 emtek.com

View this product online at <https://marathonhardware.com/pd/E86491US26>

