





Vibo Flybox Lamina 45cm IronSand

Part Number: 041-VFLYBOX45-LAMINA-IS

	Included in this webkit	Qty Required
	Flybox shelves 45cm Lamina Ironsand Part #: 041-VLFB45-IS	1
	Flybox frame for door 18" anthracite Part #: 041-VFB45-AG	1

Vibo FlyBox Lamina 45cm (450mm) IronSand

The Vibo FlyBox offers an innovative solution for modern homes, tackling the issue of optimizing space in 450mm/500mm and 600mm blind corner cabinets.

Basket Finish	Anthracite Grey
Closing Type	Soft-Close
Depth	489 mm
Finish	Anthracite Grey
Frame Finish	Anthracite Grey
Height	560 mm
Load Capacity	25 kg per tier
Reversible	Reversible
Suggested for Cabinet (Door) Width	45 cm
Width	825 mm

Product Advantages

- Available in 2 sizes:
 - 45/50 door opening (18" / 19-5/8")
 - 60 door opening (24")
- Soft-close
- Hinge-operated, the system is independent from the door.
- Space and ergonomomy maximized
- Quick-mounting
- Reversible, Fly Box is designed for a left or right application
- 25 kg load capacity per tier



Technical Documents

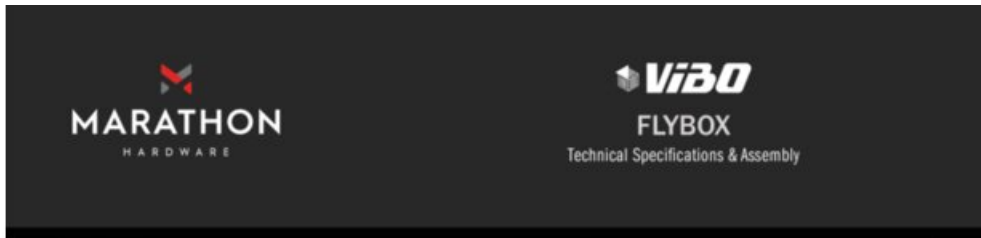

Vibo FlyBox

Product Features



The Vibo FlyBox is a modern solution for 450mm/500mm and 600mm blind corner cabinets. This easily accessible unit allows four storage boxes to be pulled out from the cabinet with minimal effort and soft-close functionality provides a whisper quiet return to the cabinet interior. Thin, yet rigid sidewalls, a high load capacity and reversible installation make the FlyBox as rugged and reliable as it is beautiful and convenient.

- Two sizes available: 450mm/500mm (18" / 19 1/4") or 600mm (24")
- Full soft-close
- Two drawers per tier
- Snap together storage boxes streamline assembly
- Reversible for left or right side installation, simplifying the ordering process
- Load capacity: 25kg (55lbs) per tier

What's In the Box

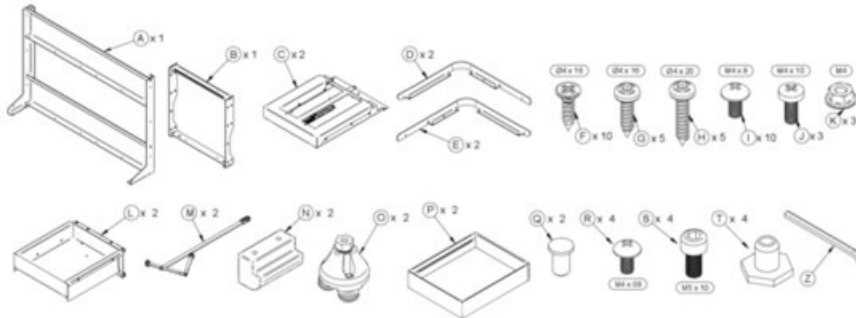

Ordering Guide

Size	Dimensions (W x D x H)	Part#
45/50cm (18"/19 1/4")	825mm x 489mm x 560mm (32 1/8" x 19 1/4" x 22 1/8")	041-VFLYBOX45-LAMINA-IS
60cm (24")	975mm x 489mm x 560mm (38 3/8" x 19 1/4" x 22 1/8")	041-VFLYBOX60-LAMINA-IS

800.840.1228 / MARATHONHARDWARE.COM

View this product online at <https://marathonhardware.com/pd/041-VFLYBOX45-LAMINA-IS>



Technical Documents



MARATHON
HARDWARE

VIBO FLYBOX



800.840.1228 | MARATHONHARDWARE.COM

ViBO

INTRODUCING Vibo FlyBox

The Vibo FlyBox is a modern solution for 450mm/500mm and 600mm blind corner cabinets. This easily accessible unit allows four storage boxes to be pulled out from the cabinet with minimal effort and soft-close functionality provides a whisper quiet return to the cabinet interior. Thin, yet rigid sidewalls, a high load capacity and reversible installation make the FlyBox as rugged and reliable as it is beautiful and convenient.

Product Features:

- Two sizes available: 450mm/500mm (18" / 19 1/4") or 600mm (24")
- Full soft-close
- Two drawers per tier
- Snap together storage boxes streamline assembly
- Reversible for left or right side installation, simplifying the ordering process
- Load capacity: 25kg (55lbs) per tier

View this product online at <https://marathonhardware.com/pd/041-VFLYBOX45-LAMINA-IS>

