



*Quick Tech*



WORKTOP  
CONNECTORS





# SYMBOLS AND FINISHES LEGEND

## SYMBOLS

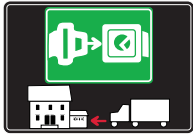

= SHELF SAFELY LOCKED DURING TRANSPORTATION AND AT HOME.



= ANTI-TURNOVER LOCKING SYSTEM



= NORMS / PATENTS



= PHILLIPS / POZIDRIV



= WITH BUFFER



= PART NO.



= BLADE SLOT



= WITH MAGNET



= PCS. PER PACKAGE



= COMBI SLOT



= HEXAGONAL SOCKET



= NEWTON



= CAPACITY LOADING



= HEXALOBULAR SOCKET



= FRICTION



= WOOD / GLASS THICKNESS



= COUNTERSUNK HEAD



= AUTOMATIC



= HOLE DIAMETER



= PAN HEAD



= DROP DOWN



= DIAMETER



= FLANGE HEAD



= LENGTH



= FLAT HEAD



= STANDARD HINGE



= HEIGHT



= TRILOBULAR SCREW



= KIMANA HINGE



= RIGHT VERSION



= SELF-TAPPING SCREW



= FLAP HINGE



= LEFT VERSION



= EURO THREAD



= WITH SPRING



= SETTING CODE



= METRIC THREAD



= WITHOUT SPRING



= PCS. PER PAD



= PRE-INSERTED SCREW



= REVERSED SPRING



= CUT ON REQUEST



= PRE-INSERTED SCREW AND SPREADING BUSH



= SELF ADHESIVE



= WITH FLANGE

NOTE: Printing errors and omissions may exist despite our best efforts to ensure accuracy. We reserve the right to alter specifications without notice.

## MATERIALS

<b>ZA</b> = Zinc Alloy	<b>ST</b> = Steel	<b>HSS</b> = High Speed Steel	<b>BR</b> = Brass	<b>ABS</b> = Acrylonitrile Butadiene Styrene
<b>ZAnk</b> = Nickel-plated Zinc Alloy	<b>STzk</b> = Zinc-plated Steel	<b>AL</b> = Aluminium	<b>WD</b> = Wood	<b>EVA</b> = Ethylene Vinyl Acetate

**EP** = **ENGINEERING PLASTIC**

+ **EP** = other engineering plastic available on request

**SR** = **SOFT RUBBER** + **SR** = other soft rubber available on request

<b>EPn</b> = Natural Engineering Plastic	<b>EPc</b> = Clear Engineering Plastic	<b>SRn</b> = Natural Soft Rubber
<b>EPw</b> = White Engineering Plastic	<b>EPg</b> = Grey Engineering Plastic	<b>SRw</b> = White Soft Rubber
<b>EPwg</b> = Water Green Engineering Plastic	<b>EPa</b> = Anthracite Engineering Plastic	<b>SRb</b> = Black Soft Rubber



## FINISHES



= OTHER FINISHES AVAILABLE ON REQUEST

PART NO.	FINISHES	PART NO.	FINISHES	PART NO.	FINISHES
00	Insignificant finish	IF	Middle Grey	RO	Red
AA	Natural	IJ	Light Grey	UT	T-Met 9007
AB	White	IL	Grey 20	UZ	T-Met
AE	White 9010	IN	Grey met. 26	WA	Bronzed
EA	Black	JB	Bright Aluminium	WI	Burnished
EC	Matt Black	JC	Aluminium - Chrome	XD	Satin-finished Steel
EE	Anthracite	JD	Matt Aluminium	YA	Nickel-plated
EW	Grey 9007	JE	Satin-finished Aluminium	YB	Bright Nickel-plated
FU	Gunmetal	JF	Aluminium - Brass	YC	Matt Nickel-plated
FV	Gunmetal V52	JG	Aluminium 5	YD	Satin-finished Nickel-plated
GR	Raw	JL	Aluminium PE 11	YQ	Black Nickel
HA	Brass-Plated	JM	Aluminium RAL 9006	Z9	Black Zinc
HH	Tropicalized	KA	Chrome	ZA	Zinc alloy
HL	Raw Brass	KB	Bright Chrome	ZN	Zinc-plated
HX	Graphite	KC	Matt Chrome	ZQ	Bright Gold
IA	Grey	LD	Brown 8019	ZY	Titanium
IB	Metallic Grey	NN	Metallic Beige	ZZ	Clear

## QUICK TECH



QUICK TECH has been conceived to join two worktops or panels together.

It consists of two parts:

- main body with tightening dowel M8x64, M8x100 or M8x150;
- round cap to suit the dowel head.

The installation is fast and simple as the two parts don't fall when placed in position.

The fastening becomes easier by using an S6 mm allen wrench, or even better, a cordless driver.

It is suitable for worktops and panels minimum 25 mm thick.

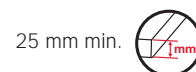

### INSTALLATION

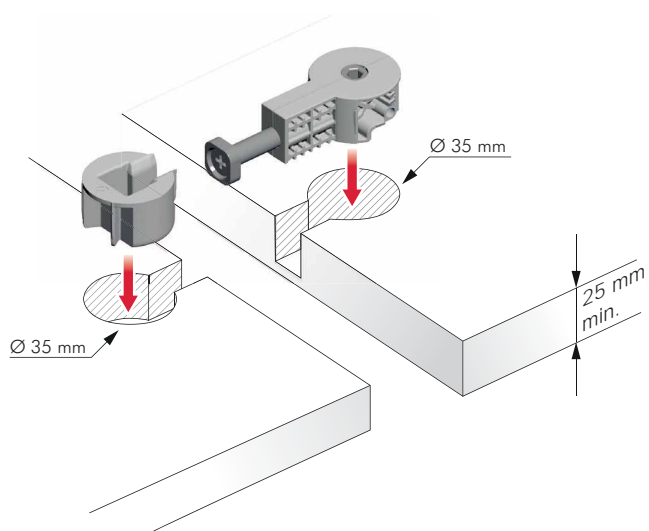

### VERSIONS

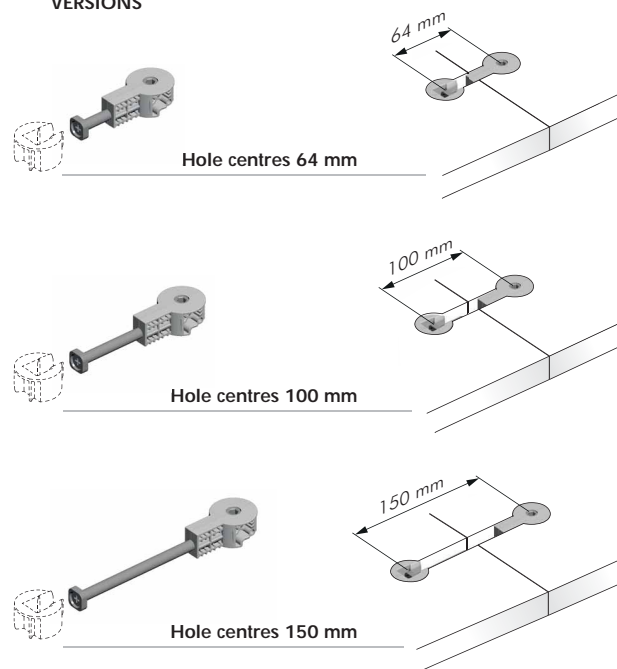

### ASSEMBLING



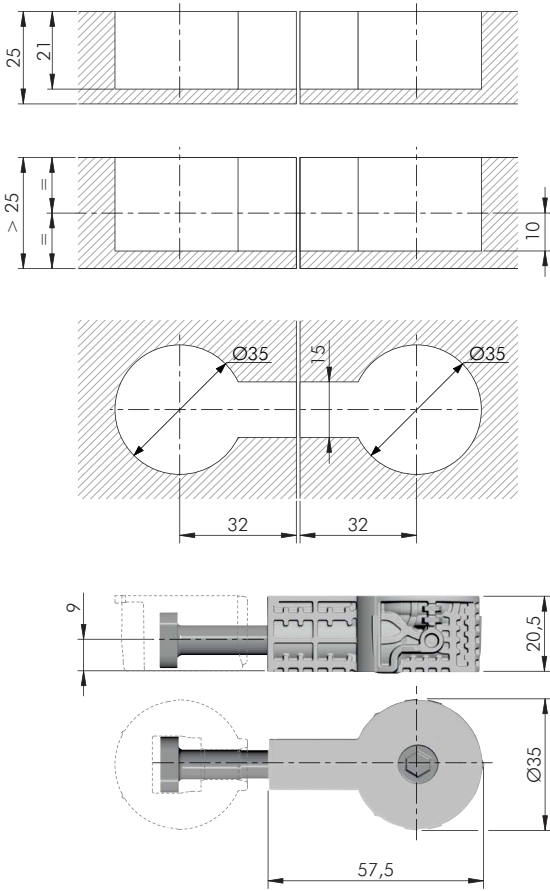

	= Ø 35 mm		= S6
	ZA		ST
	EP		= 250 pcs.
	2162105000		

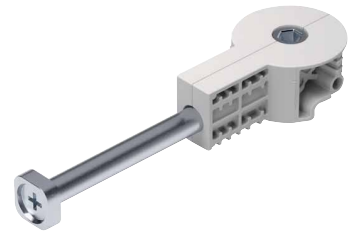
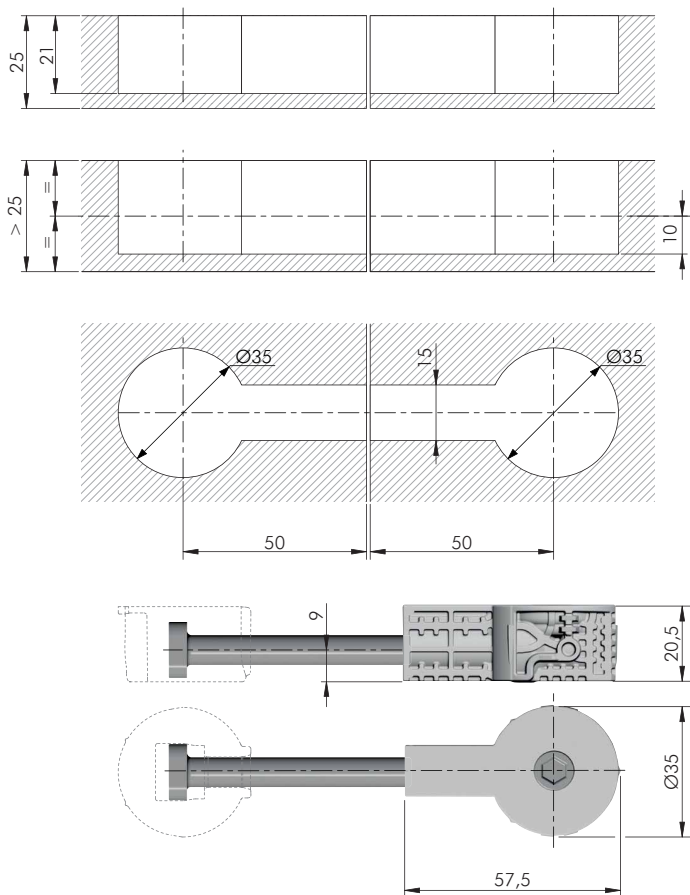

	= Ø 35 mm		= S6
	ZA		ST
	EP		= 125 pcs.
	2162106000		

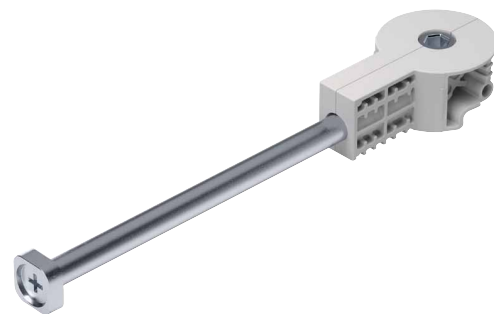
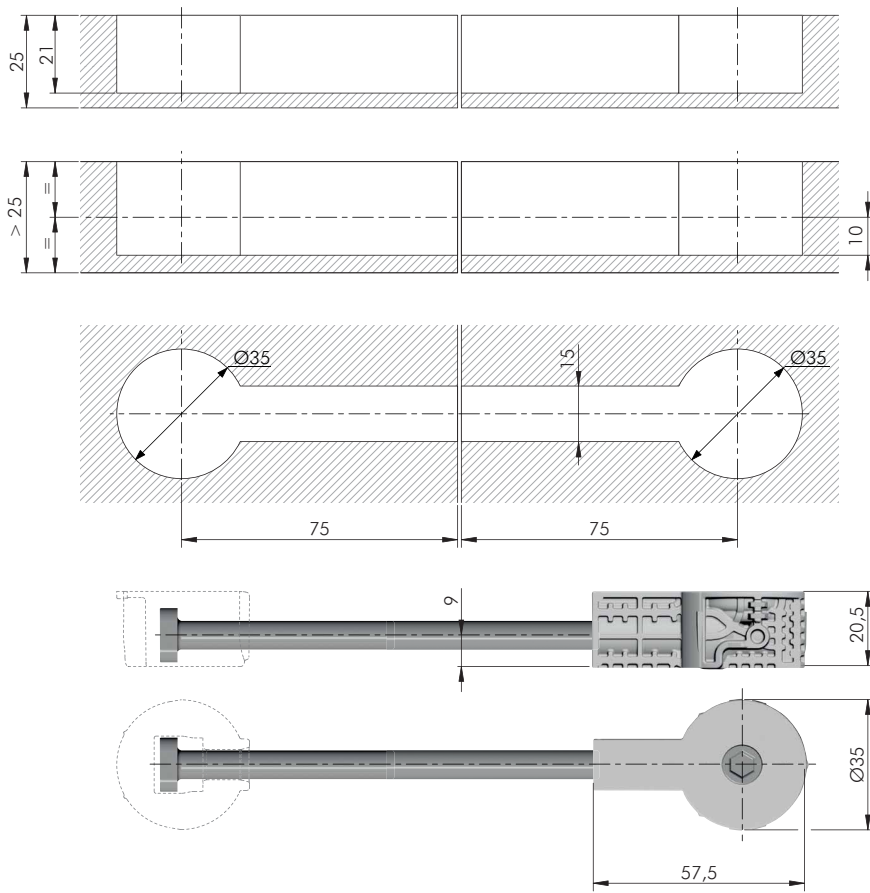

	= Ø 35 mm		= S6
	ZA		ST
	EP		= 125 pcs.
	123		
<b>2162107000</b>			

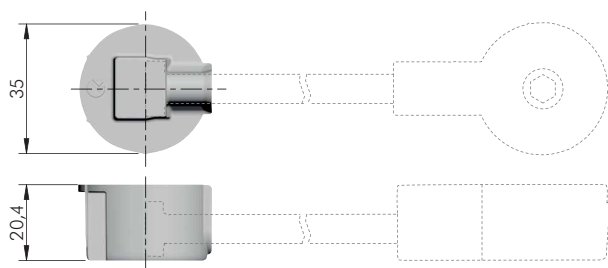

	= Ø 35 mm		= 250 pcs.
	EP		
	123		
<b>2162001000</b>			



**DRILL BIT FOR QUICK TECH**

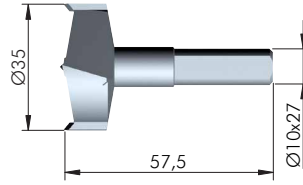
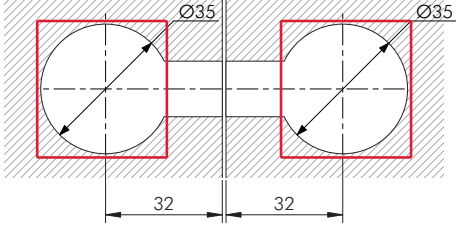

HSS	= on request
<b>3175201000</b>	

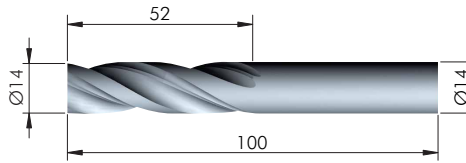
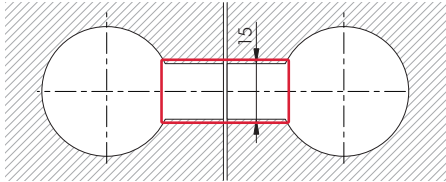

HSS	= on request
<b>1621454000</b>	

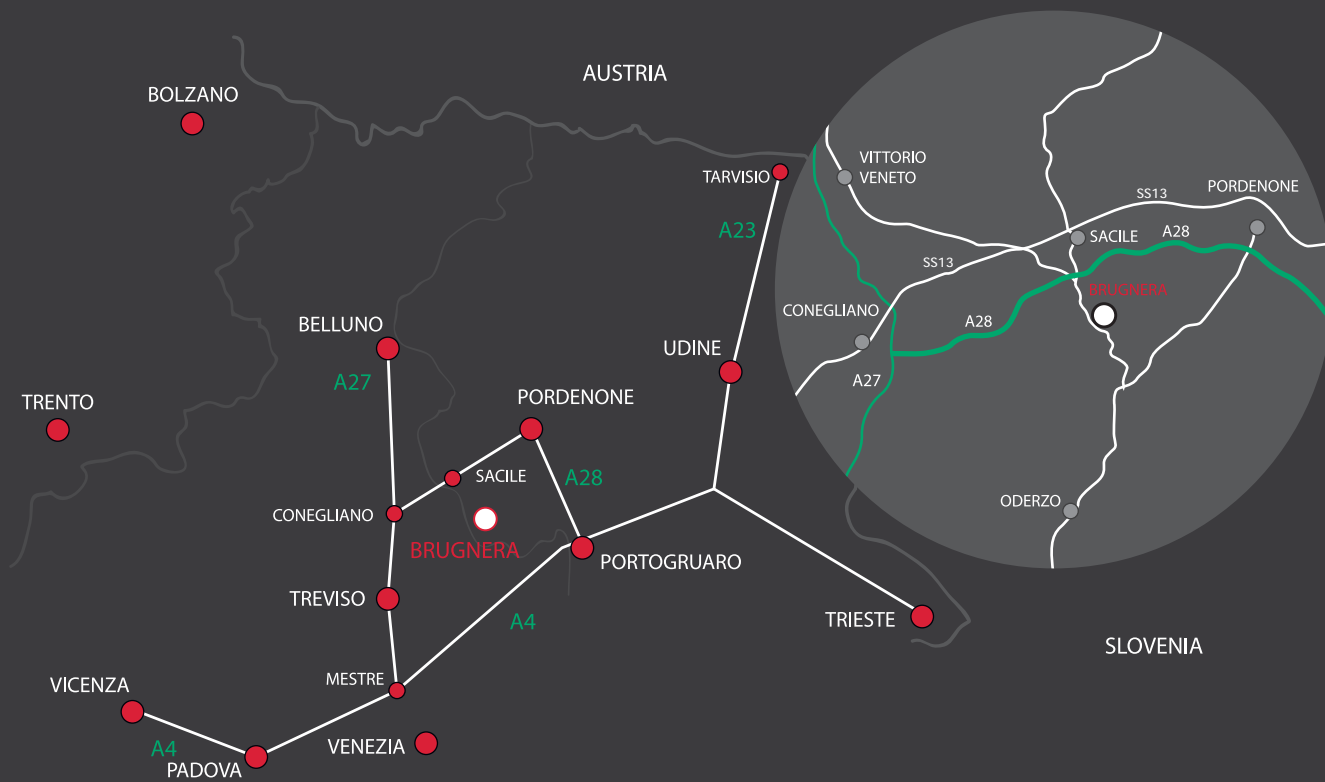

[www.italianaferramenta.it](http://www.italianaferramenta.it)